

POMPA PER VUOTO AD ANELLO LIQUIDO

LIQUID RING
VACUUM PUMP

AL3360A

MODELLO AL3360A



La pompa per vuoto ad anello liquido modello AL3360A è del tipo monostadio con valvola, in esecuzione ad asse nudo. Compatta, versatile nelle prestazioni, raggiunge 180 mbar ass., adatta ad aspirare vapori e gas con tracce di liquidi, non necessita di lubrificazione, manutenzione contenuta. Disponibile in esecuzione standard o in acciaio inox. A scelta tenute a baderna o meccaniche.

The liquid ring vacuum pump model AL3360A is single stage type fitted with vary port valve, bareshaft version. Compact, flexible in performance, achieves 180 mbar abs., suitable to suck vapors and gas with liquid carry over, oil free operation, limited maintenance required. Available in standard version or in stainless steel. Option for gland packing or mechanical seals.

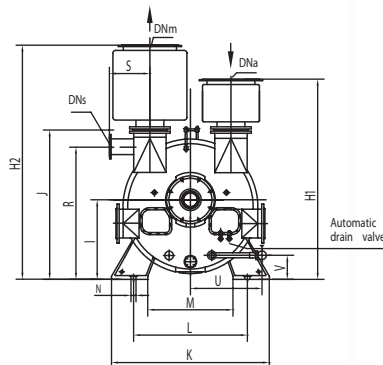
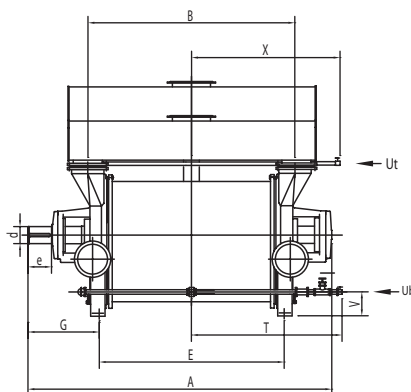

Emmecom s.r.l.

Via P. Nenni, 70
20093 Cologno Monzese (MI)
Tel. +39 02 25 33 300 (r.a.)
Fax +39 02 27 307 908
www.emmecomsrl.com
sales@emmecomsrl.com



	A	B	E	G	H1	H2	K	I	J	L	M	N	R	S	T	U	V	X	Peso totale - Kg Total Weight - Kg
AL3360A	1985	1290	1150	500	1370	1570	1110	560	1050	800	660	ø 35	930	245	995	605	170	1025	2200

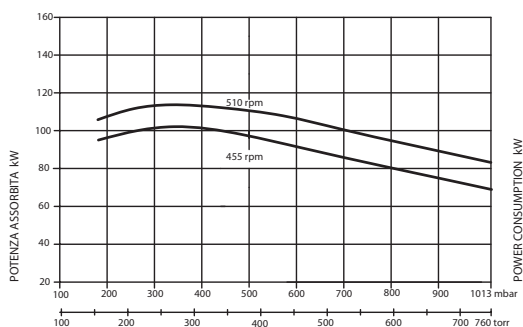
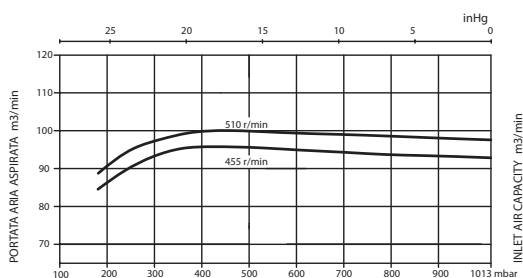

DNa	250 - 10"	Attacco aspirazione Suction nozzle
DNm	250 - 10"	Attacco mandata Discharge nozzle
DNs	125 - 5"	Attacco scarico Water discharge nozzle
Ub	G 1" 1/2	Attacco per liquido di esercizio Service liquid connection
Ut	G 3/4"	Attacco flussaggio esterno tenuta (se richiesto) External seal flushing (if requested)
d	120	Ø Albero - Shaft
e	165	Sporgenza d'albero - Shaft extention

I valori di portata sono riferiti ad aria saturata, alla temperatura di 20°C, alla pressione atmosferica di mandata (1013 mbar), e all'impiego di acqua alla temperatura di 15°C. Tolleranza di prestazione ± 10%. Nell'esecuzione in inox la portata diminuisce del 5%. I dati sopraindicati possono essere variati senza preavviso.

The given capacity values are referred to saturated air at the temperature of 20°C, atmospheric discharge pressure (1013 mbar), and of supply of service water at 15°C temperature. Performance tolerance ± 10%. Stainless steel construction is 5% less performing. The data may change without any notice.

a i r m o v i n g